





Load Capacity

| Jib | Max Capacity | Radius & Capacity | | | | | | | | |
|------|-----------------|-------------------|------|------|------|------|------|------|------|------|
| | | m | 24.0 | 30.0 | 32.0 | 33.0 | 35.0 | 37.0 | 38.0 | 40.0 |
| 40 m | 3.2~32: 2.9 ton | kg | 2900 | 2900 | 2900 | 2788 | 2629 | 2486 | 2421 | 2300 |
| 35 m | 2.5~33: 2.9 ton | kg | 2900 | 2900 | 2900 | 2900 | 2700 | | | |
| 30 m | 1.6~30: 2.9 ton | kg | 2900 | 2900 | | | | | | |
| 24 m | 0.8~24: 2.9 ton | kg | 2900 | | | | | | | |

Specification

| Free Standing | | 36 m | | | Max Install Height | | 130 m | | |
|---------------|---|---------|-------------------------|--|--------------------|----------------|---|--|--|
| Hoist |  | Speed | 30/ 55 m/min | | 18.5 kw x 4P | 380 V 60 Hz | Wire Drum : 350m / ø 12mm (19x7 IWRC B Grade) Non Rotating | | |
| | | Reducer | 4180Nm, i=1/35 | | | | | | |
| | | Brake | Spring Close Disc Brake | | | | | | |
| Luffing |  | Speed | 4.2 m/min | | 18.5 kw x 4P | | Wire Drum : 200m / ø 12mm (6xFi(25) IWRC C Grade) | | |
| | | Reducer | 3200Nm, i=1/35 | | | | | | |
| | | Brake | Spring Close Disc Brake | | | | | | |
| Slewing |  | Speed | 0~0.5 rev/min | | 3.75 kw x 2 EA | | | | |
| | | Reducer | i=1/187 | | | | | | |

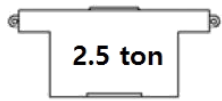
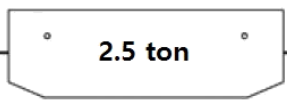
Ballast

| A type | A' Type | B type |
|---|---|---|
|  2.5 ton |  2.5 ton |  1.8 ton |

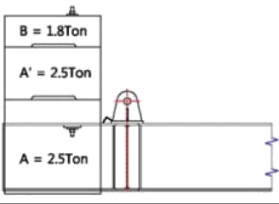
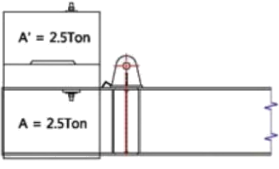
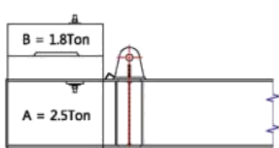
| Jib | Weight | Installment |
|--------------|------------------|---|
| 40 m 35 m | A+A'+B = 6.8 ton |  |
| 30 m | A+A' = 5.0 ton |  |
| 24 m | A+B = 4.3 ton |  |

Foundation

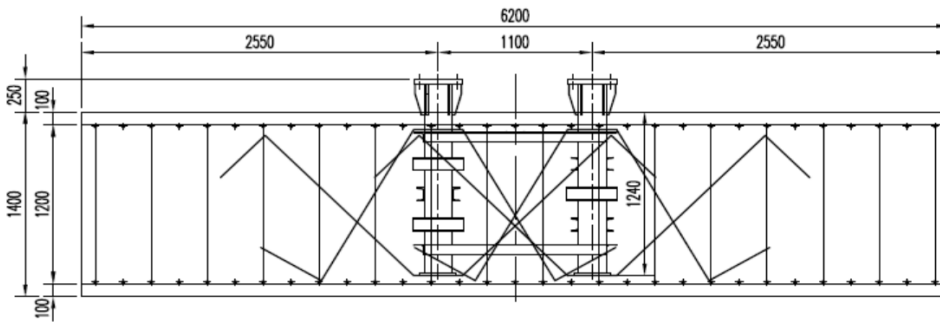
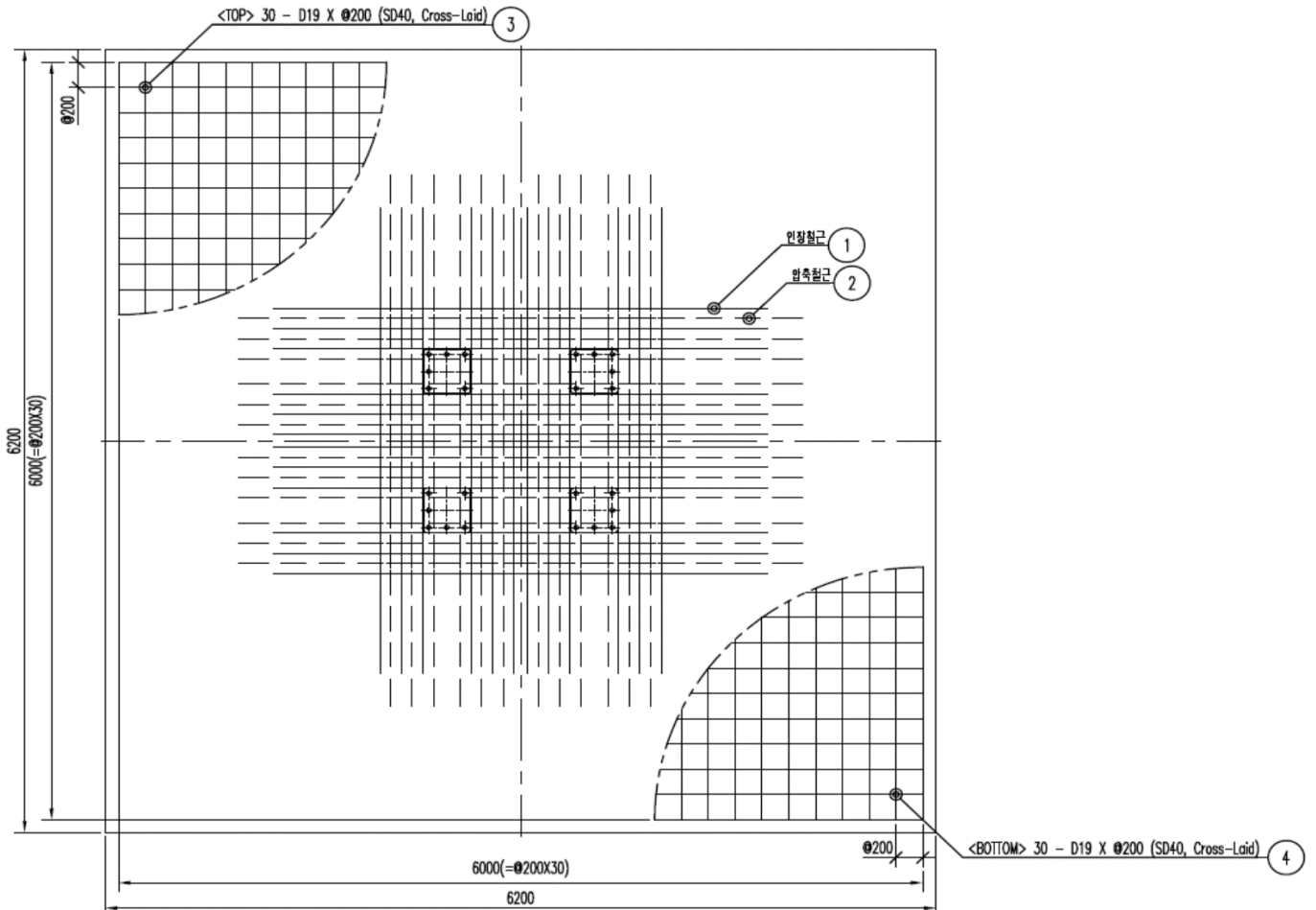

① 인장철근

② 압축철근

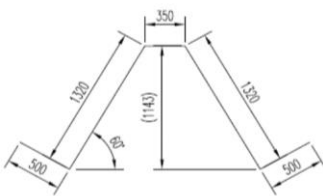

12 X D22, L = 4.0m per Anchor
4(Anchor) X 12 = 48Pieces (SD40)

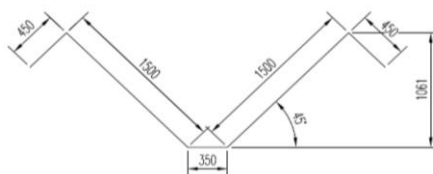

12 X D22, L = 4.25m per Anchor
4(Anchor) X 12 = 48Pieces (SD40)

③ <TOP> Cross Laid D19 X @200 X 6000L - 60EA (SD40)

④ <BOTTOM> Cross Laid D19 X @200 X 6000L - 60EA (SD40)







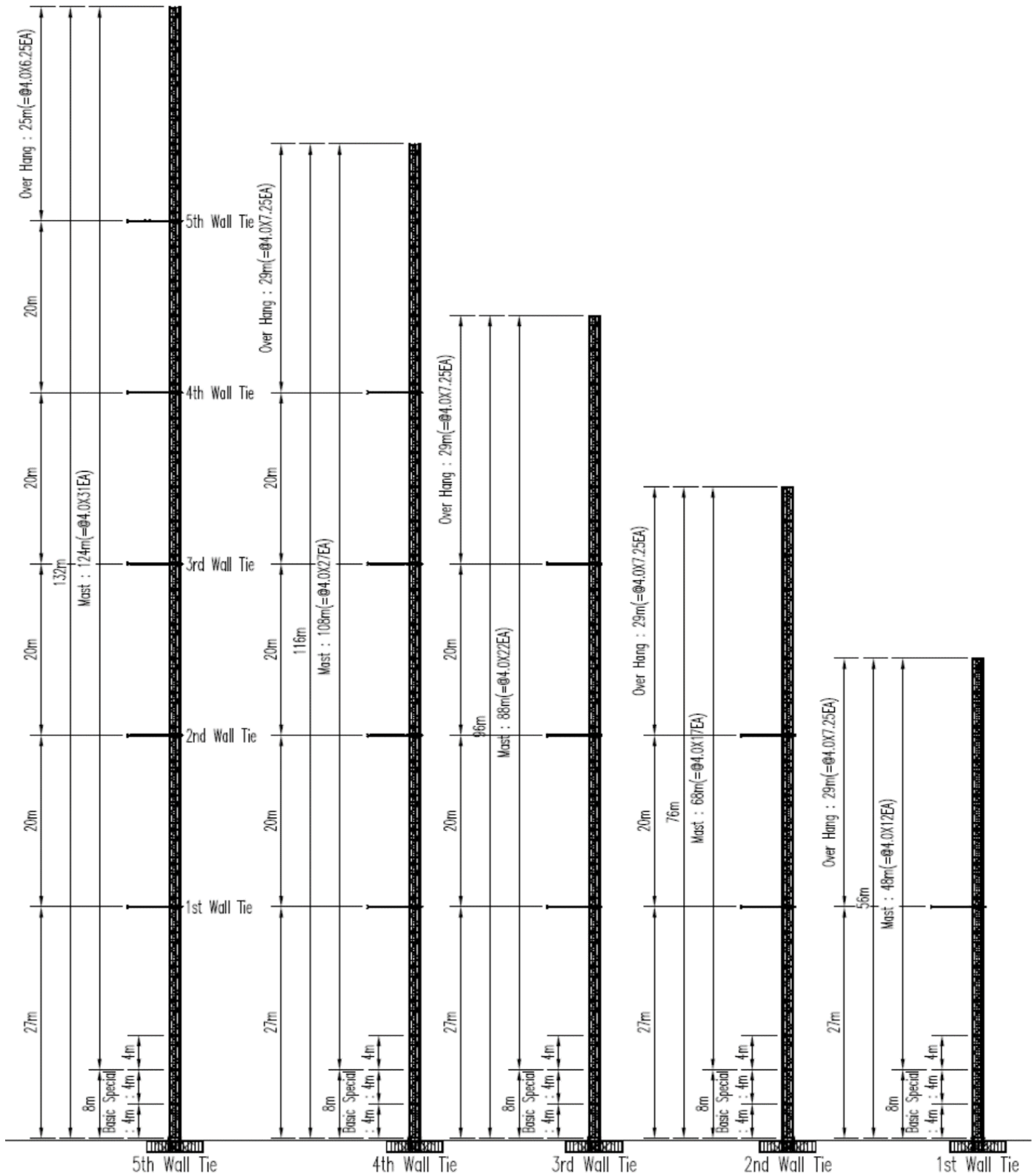



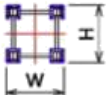

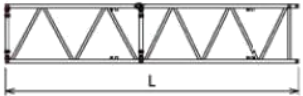
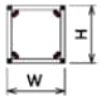
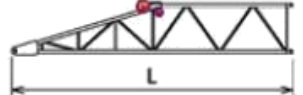
* NOTE.

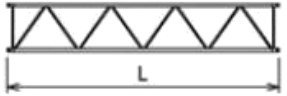
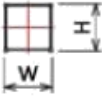
1. Concrete 압축강도 : 240kg/cm²
2. 허용지내력 : 16t/m²
3. 철근 : SD40
4. 버림 콘크리트 타설 후 Anchor를 가설치한 상태에서 Basic Mast와 결합되는 4기소 Plate의 레벨을 정확히 맞추고, 콘크리트 타설이나 외부의 힘에 의해 움직이지 않도록 충분한 보강을 한 후, 레벨을 밀히 정확히 하여야 함.
5. 지내력이 부족한 지역에서는 Tower Crane의 기초가 침하되어 Tower Crane의 안전상에 위험이 따르므로 Friction Pile 및 기타 방법으로 보강되어 저야 한다.

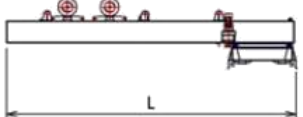
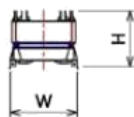
Mast Installment



Packing List

| No | Q'ty | Description | Length L | Width W | Height H | Weight (kg) | | | |
|----|------|--------------------------------------|---|---|---|----------------|-------|------|------|
| | | | | | | | | | |
| 1 | 3 | Basic Mast Mast |  |  |  | 4.0 | 1.45 | 1.45 | 1590 |
| | | | | | | 4.0 | 1.30 | 1.30 | 1250 |
| 2 | 1 | Telescopic Cage |  |  | 8.9 | 1.8 | 1.8 | 3300 | |
| 3 | 1 | Jib #1 |  |  | 6.35 | 1.125 | 1.125 | 510 | |
| 4 | 1 | Jib #2 | | | 6.31 | 1.125 | 1.125 | 510 | |
| | 1 | Jib #3 | | | 6.31 | 1.125 | 1.125 | 405 | |
| | 1 | Jib #4 |  |  | 6.31 | 1.125 | 1.125 | 405 | |
| | 1 | Jib #5 | | | 6.31 | 1.125 | 1.125 | 425 | |
| | 1 | Jib #6 | | | 4.81 | 1.125 | 1.125 | 320 | |
| | 1 | Jib #7 | | | 6.31 | 1.125 | 1.125 | 435 | |
| 5 | 1 | Jib #8 |  |  | 2.58 | 1.125 | 1.125 | 220 | |
| 6 | 1 | Conter Jib | | | 7.86 | 1.83 | 1.55 | 4550 | |
| | | Turn table Winch-2set Platform |  |  | | | | | |
| 7 | 1 | Hook |  |  | 0.75 | 0.25 | 0.98 | 104 | |
| 8 | - | Weight A |  | | 1.86 | 0.85 | 0.84 | 2500 | |
| | | Weight A' |  | | 2.7 | 0.85 | 0.465 | 2500 | |
| | | Weight B | | | 2.7 | 0.85 | 0.335 | 1800 | |
| 9 | 1 | Tower Head Platform |  | | 10.8 | 1.73 | 1.2 | 2357 | |

■ 본사 및 공장

주소: 경남 양산시 산막공단북9길 112
 전화: 055-381-7823 팩스: 055-381-7825
 이메일: chungwoo2014@naver.com

■ 영업사무소

주소: 경기도 수원시 영통구 창룡대로 256번길 77,
 에이스광교타워3차, 1010호
 전화: 031-281-0886 팩스: 0303-3130-0886
 이메일: cw-sales@naver.com



청우 T&G